

13.

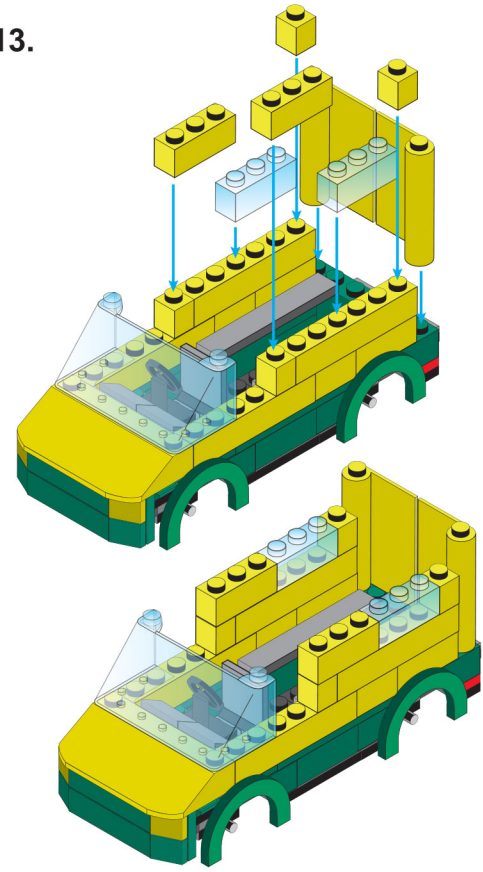

14.

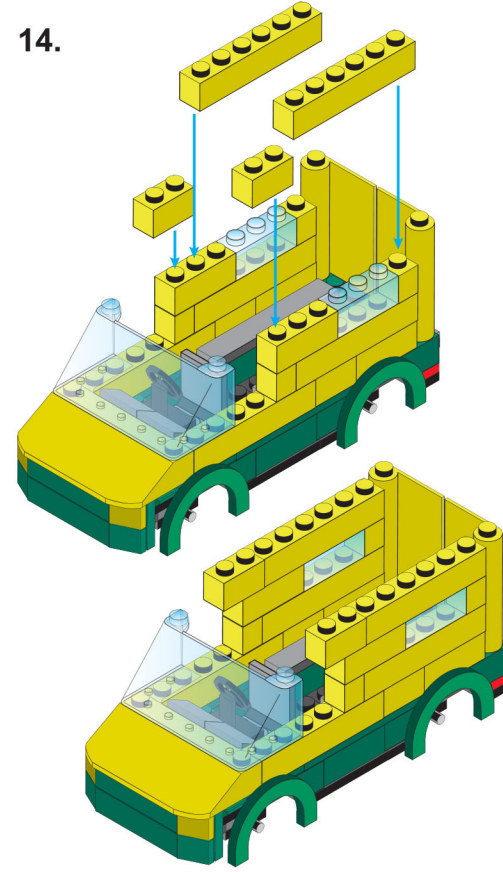

15a.

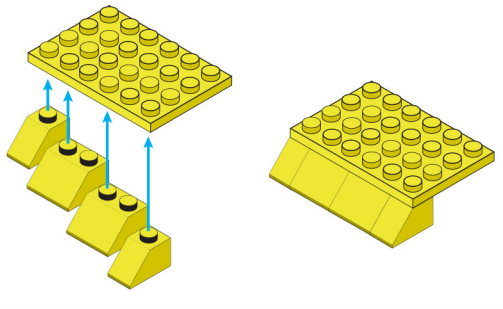

15b.

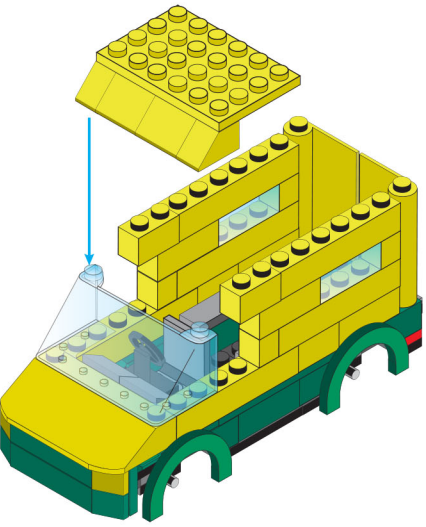

16.

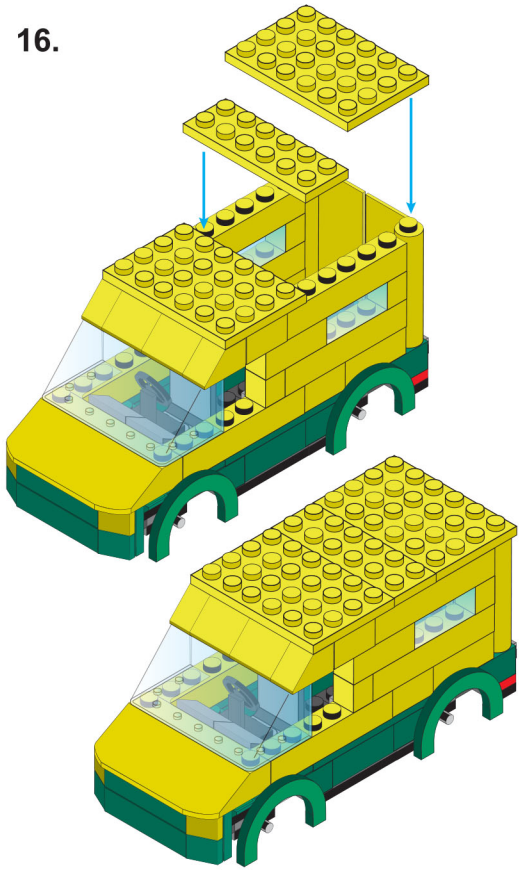

17.

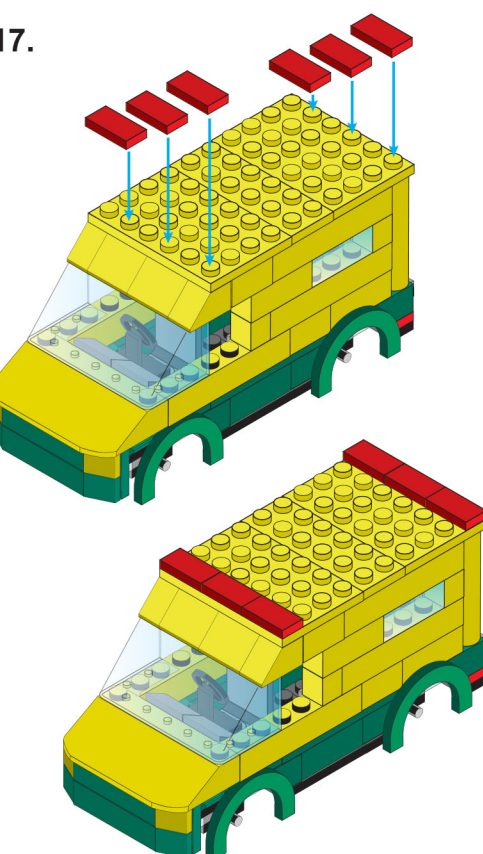

18.

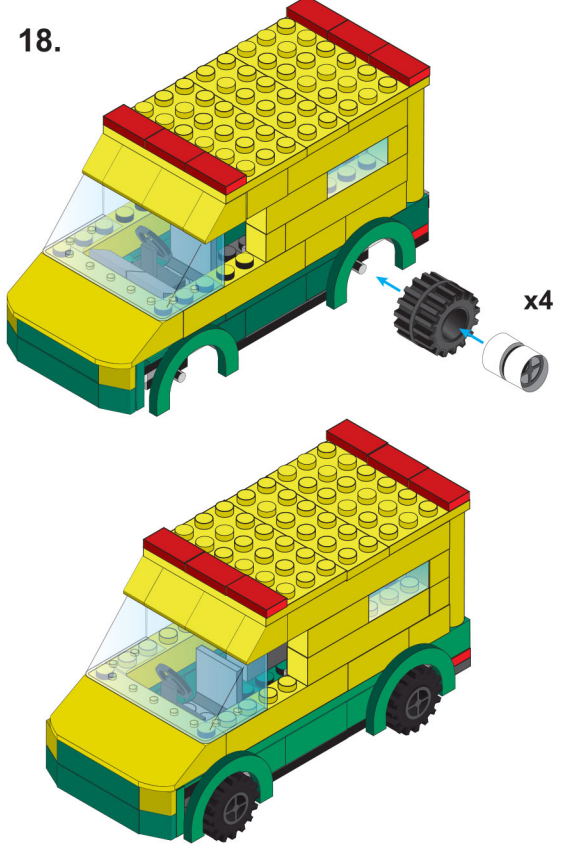

Stickers:

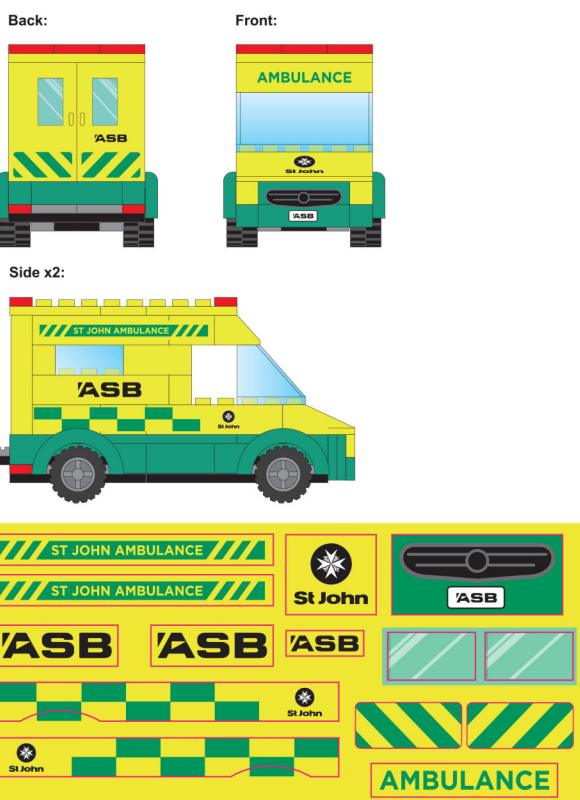

Instructions Ambulance



x1 	x1 	x3 	x1 	x1 	x1
x4 	x2 	x1 	x4 	x4 	
x2 	x2 	x2 	x2 	x4 	
x2 	x4 	x1 	x1 	x3 	
x1 	x2 	x2 	x8 	x2 	
x1 	x4 	x1 	x2 	x2 	
x1 	x2 	x2 	x1 	x1 	
x6 	x2 	x4 	x4 	x4 	
x2 	x6 				